

Βιβλιαράκι  
Μαθαίνω τους  
ΑΡΙΘΜΟΥΣ

0-10

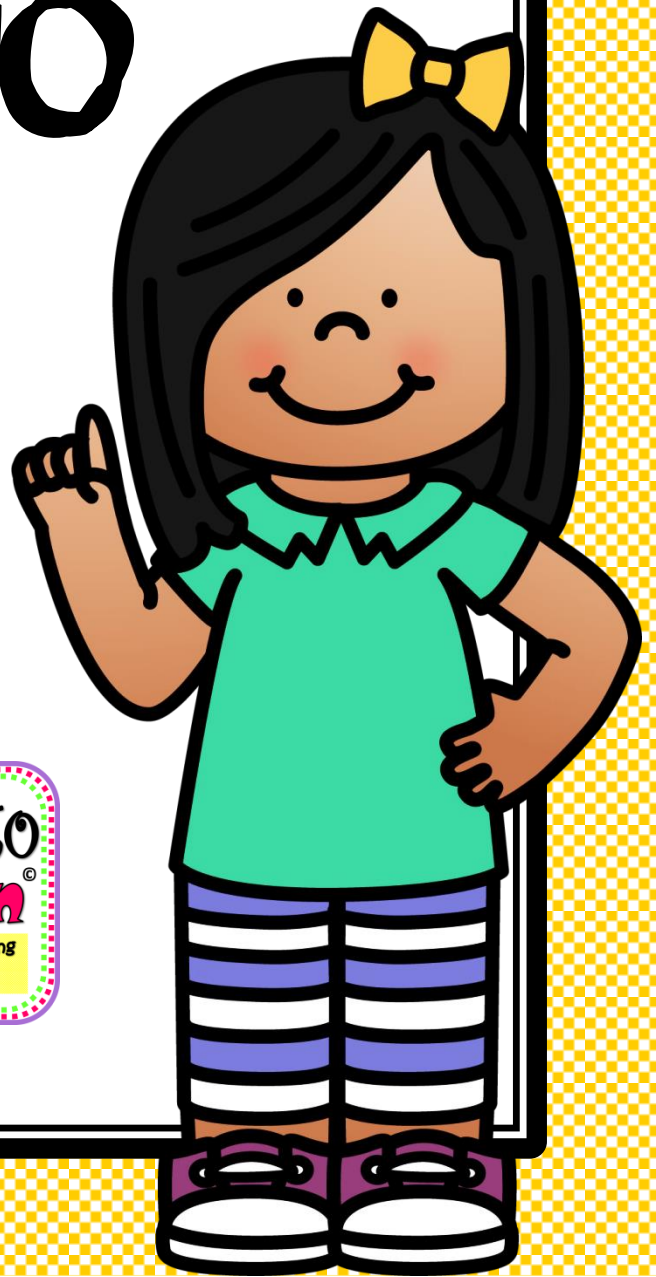

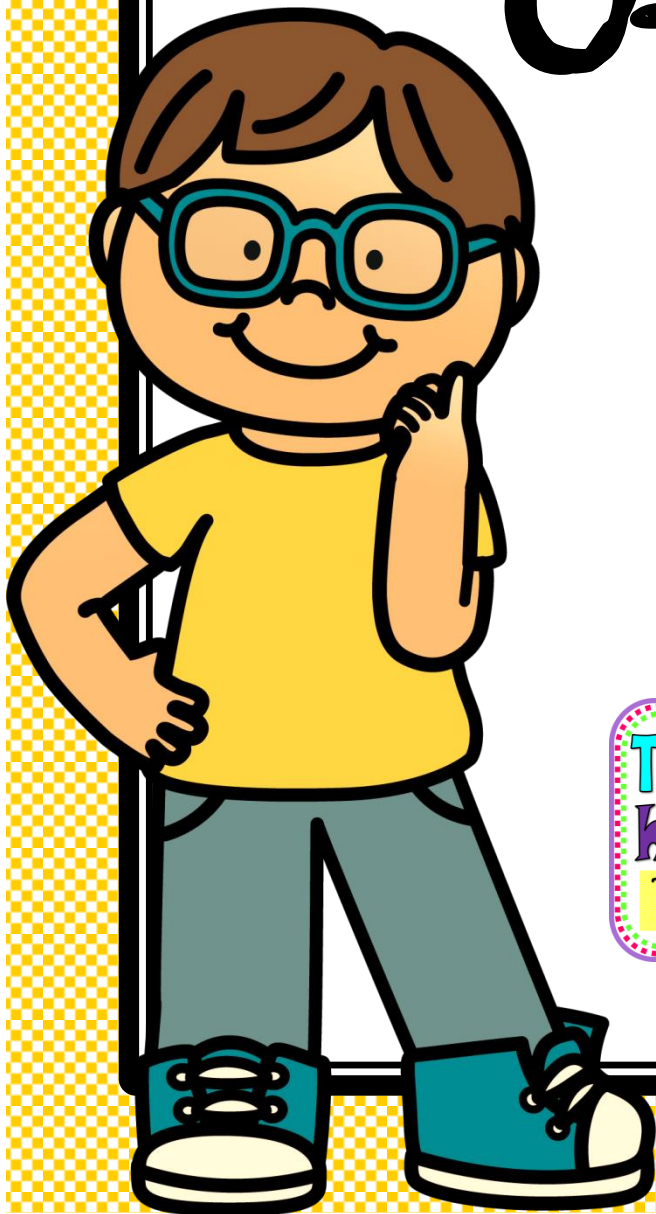
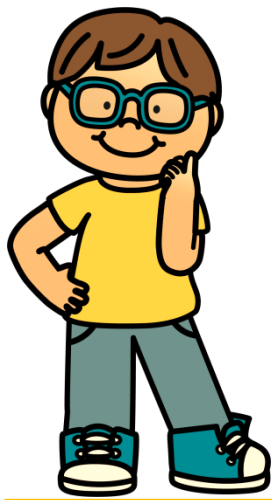

# Βιβλιαράκι

## Μαθαίνω τους ΑΡΙΘΜΟΥΣ

### 0-10

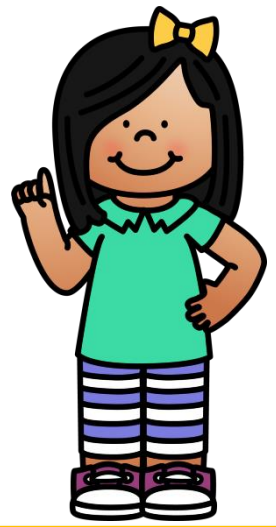

Σας ευχαριστούμε για την αγορά του παρόντος διδακτικού-υποστηρικτικού υλικού, το οποίο αποσκοπεί στο να στηρίξει κάθε προσπάθεια που κάνετε, για να βοηθήσετε τα παιδιά να γνωρίσουν και να μάθουν τους αριθμούς 0 έως 10. Το υλικό μπορεί να αξιοποιηθεί τόσο στο δημοτικό σχολείο όσο και στο νηπιαγωγείο, σε δραστηριότητες αισθητοποίησης και γραφής των αριθμών, φωνολογικής ενημερότητας, πρώτης ανάγνωσης και πρώτης γραφής, εμπλουτισμού λεξιλογίου αλλά και εκμάθησης της Ελληνικής ως δεύτερης γλώσσας. Επίσης, το υλικό είναι κατάλληλο και για δραστηριότητες στήριξης παιδιών με μαθησιακές δυσκολίες, στα πλαίσια της ειδικής εκπαίδευσης και της λογοθεραπείας. Τέλος, το υλικό είναι κατάλληλο και για την προετοιμασία των παιδιών που θα πάνε, την επόμενη σχολική χρονιά, στην Α' τάξη δημοτικού, στο σπίτι.

Το παρόν υλικό είναι διαθέσιμο μόνον για προσωπική σας χρήση. Επιτρέπεται να το τυπώσετε και να το φωτοτυπήσετε μόνον για την τάξη σας ή για το παιδί σας. Απαγορεύεται αυστηρά η οποιαδήποτε αντιγραφή, αναπαραγωγή, αναδημοσίευση, διανομή και πώληση του προϊόντος αυτού, ολόκληρου ή μέρους του.

Copyright © 2019 "Teach to heaven" – Ρέα Παπαγεωργίου  
Teaching and Learning Resources  
All rights reserved by author - creator



### Clipart and graphics credits



Αυτό το πακέτο διδακτικού — υποστηρικτικού υλικού περιλαμβάνει:

- 11 Φύλλα εργασίας με ασκήσεις γραφής και αισθητοποίησης των αριθμών
- 17 επιπλέον φύλλα εργασίας με δραστηριότητες συνδυασμού των αριθμών
- 4 συλλογές καρτελών, για την καρτελοθήκη των παιδιών
- 2 εξώφυλλα για το βιβλιαράκι, ένα για κορίτσι και ένα για αγόρι

# Μαθαίνω τους ΑΡΙΘΜΟΥΣ

1 2 3

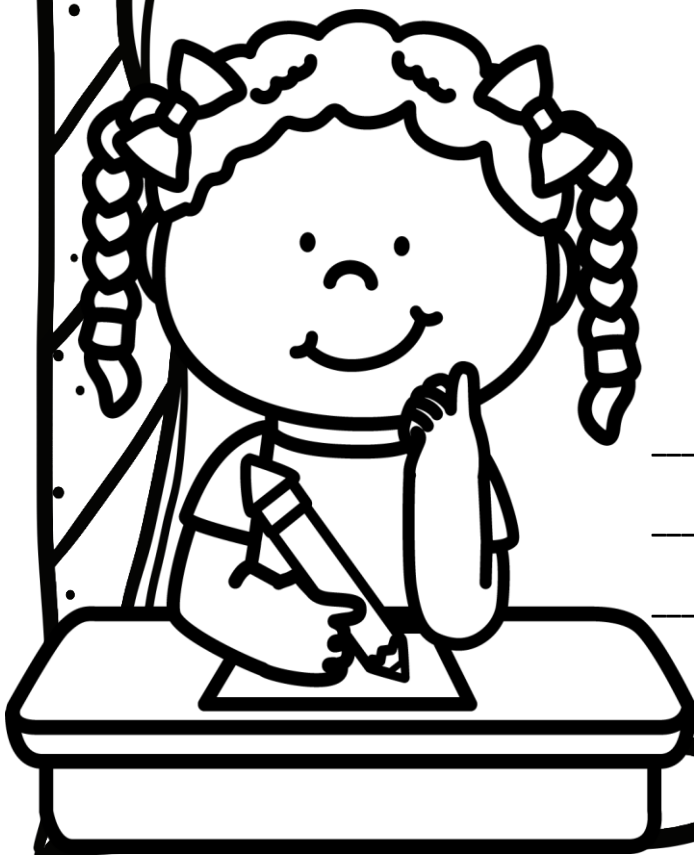

# Μαθαίνω τους ΑΡΙΘΜΟΥΣ

1 2 3

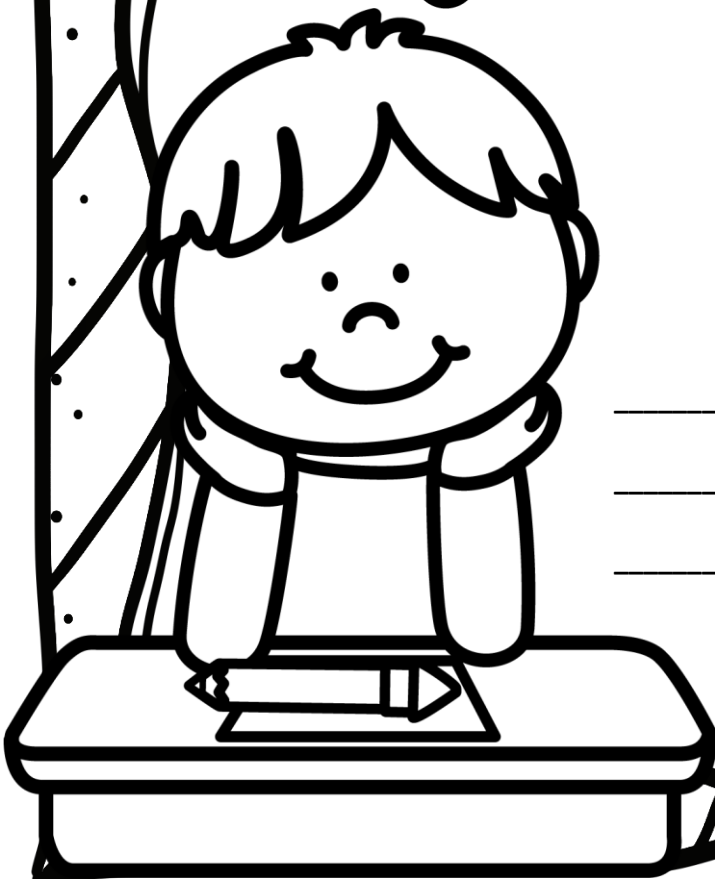

---

---

---

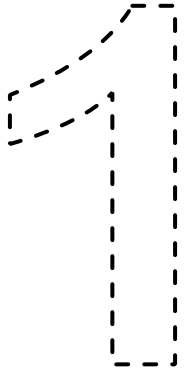

ένα

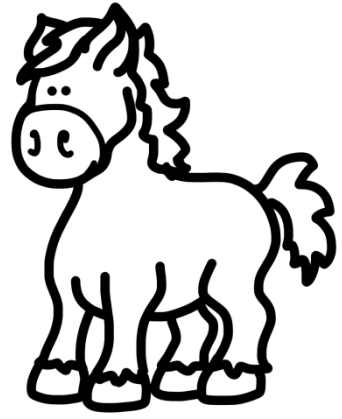

Γράφω το 1

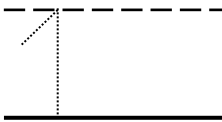

Κυκλώνω το 1

2	1	1	1
1	5	9	4
3	1	8	1
7		1	

Ζωγραφίζω  
έναν ήλιο

Χρωματίζω την τούρτα που έχει 1 κερί

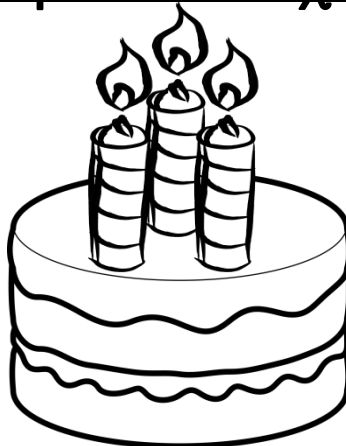

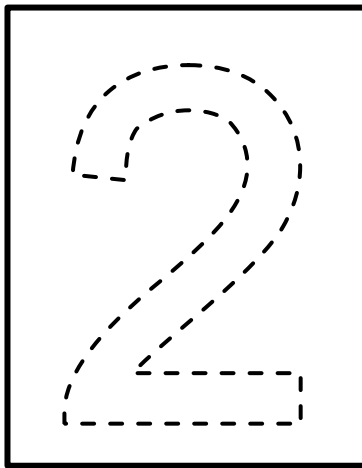

δύο

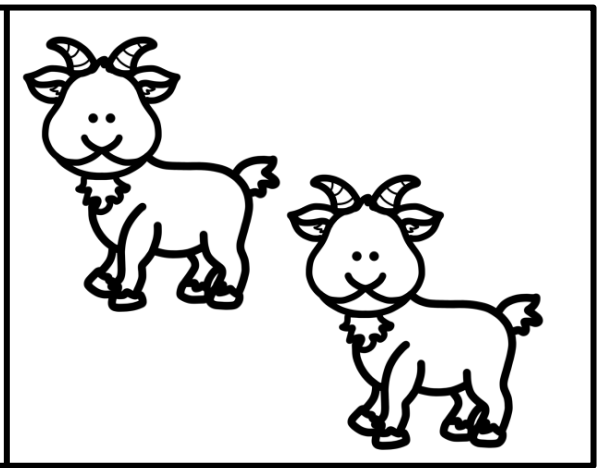

Γράφω το 2



Κυκλώνω το 2

2	0	2	8
1	2	3	6
2	5	2	2
	4	9	

Ζωγραφίζω  
δύο λουλούδια

Χρωματίζω την εικόνα που έχει 2 παιδιά

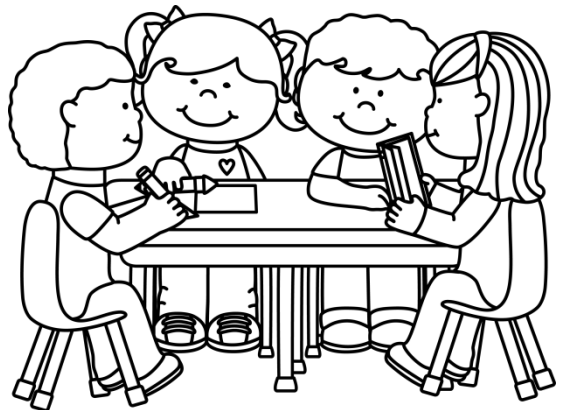

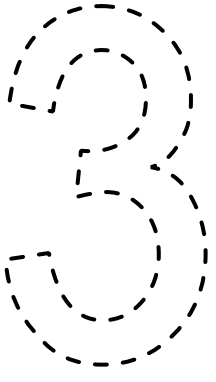

τρία

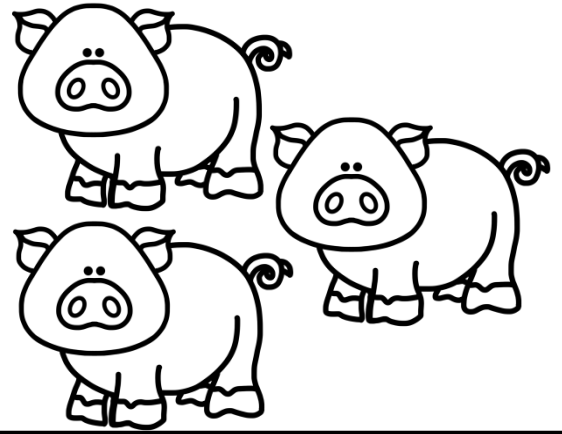

Γράφω το 3



Κυκλώνω το 3

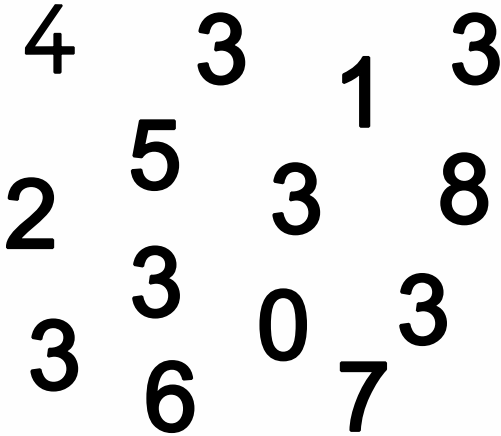

Ζωγραφίζω  
τρία λεμόνια

Χρωματίζω το ψάρι που έχει 3 μπουρμπουλήθρες

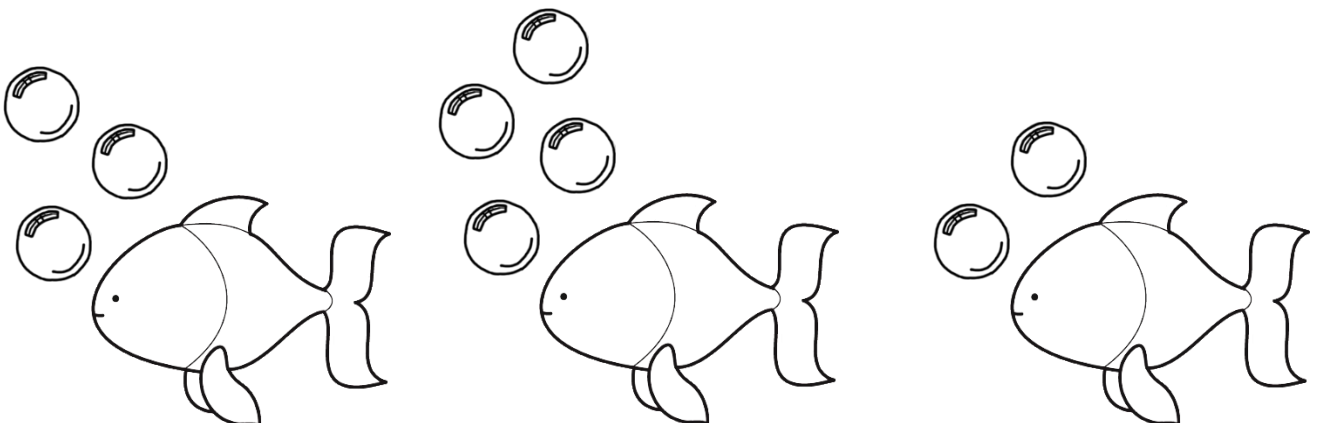



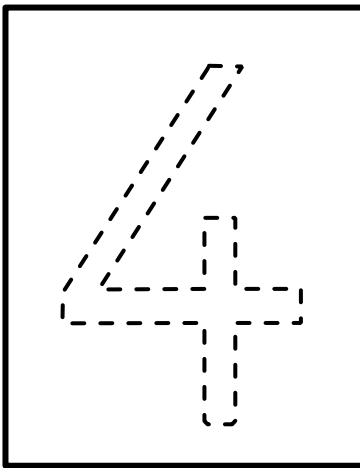

**τέσσερα**

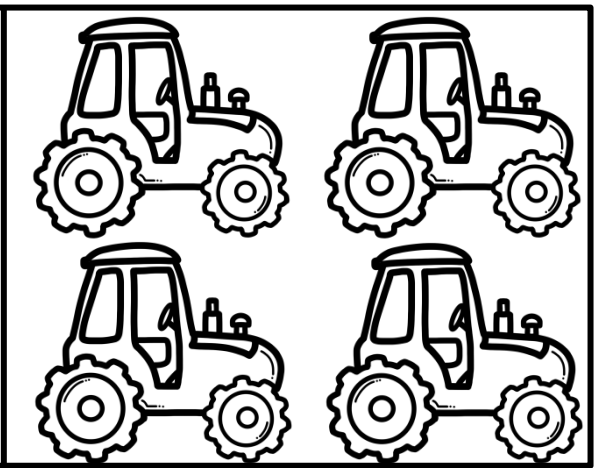

Γράφω το 4

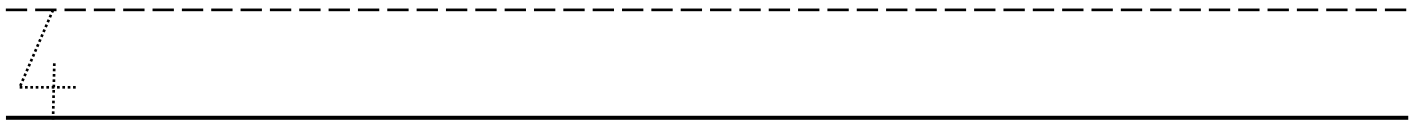

Κυκλώνω το 4

8	4	7	4
6	9	4	4
4	4	2	1
	3	4	

Ζωγραφίζω  
τέσσερα μήλα

Χρωματίζω το σακούλι που έχει 4 καραμέλες





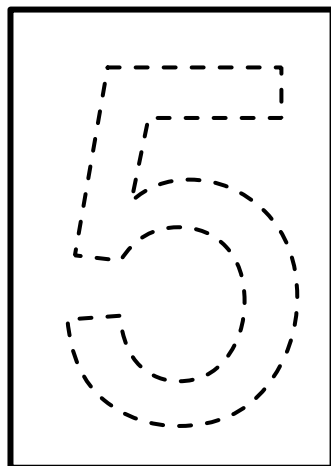

# Πέντε

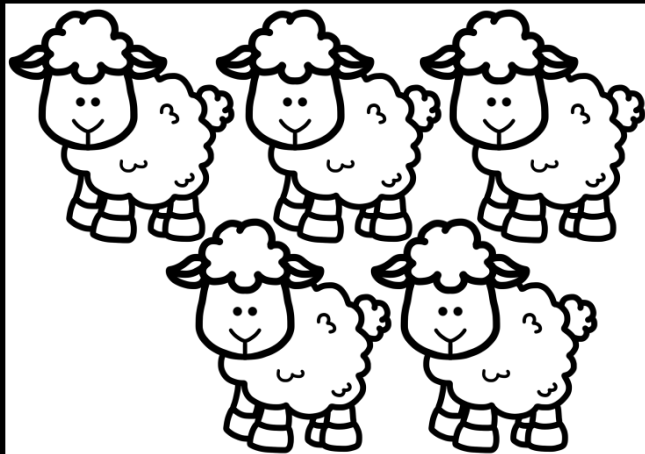

Γράφω το 5



Κυκλώνω το 5

3	1	5	5
5	5	9	6
3	2	5	5
	7	8	

Ζωγραφίζω  
πέντε σταχόνες

Χρωματίζω το χέρι που δείχνει 5

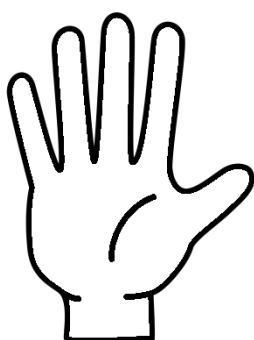

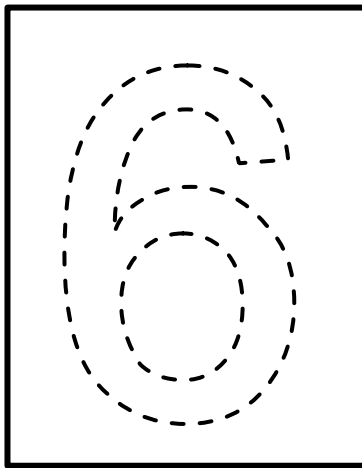

έξι

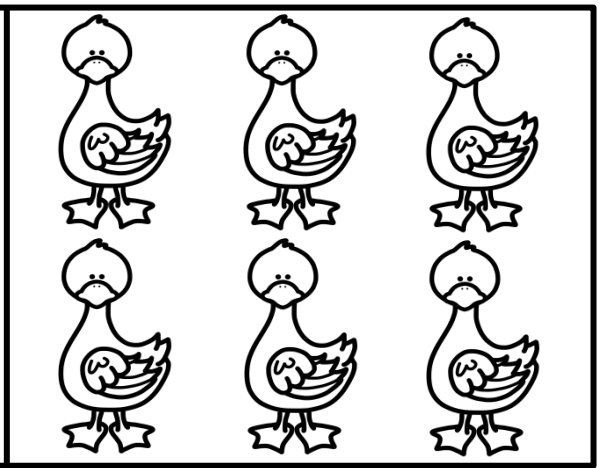

Γράφω το 6



Κυκλώνω το 6

2	6	3	6
5	6	9	6
3	2	8	6
			1

Ζωγραφίζω  
έξι τετράγωνα

Χρωματίζω το ζάρι που δείχνει 6

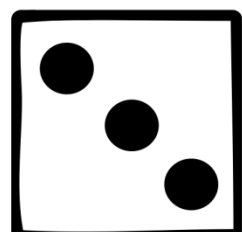
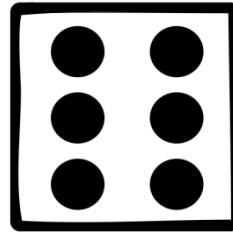
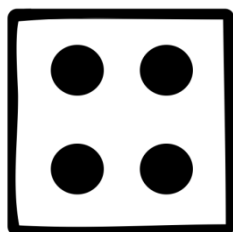
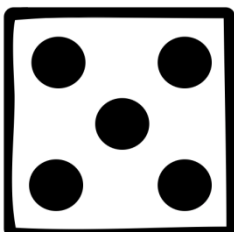

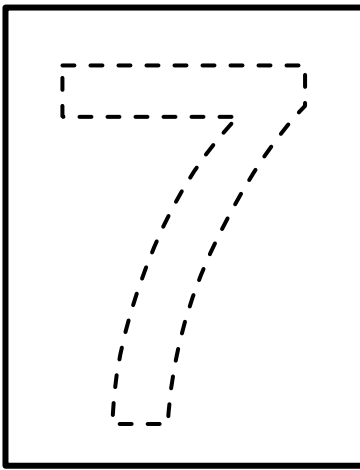

**εφτά**

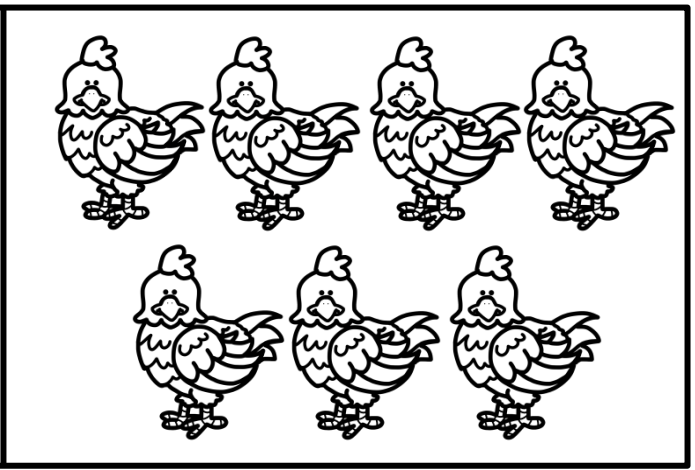

Γράφω το 7



Κυκλώνω το 7

4	9	7	7
7	8	7	3
2	0	6	7
7	7	7	

Ζωγραφίζω  
εφτά σταχόνες

Χρωματίζω το φύλλο που έχει 7 πασχαλίτσες

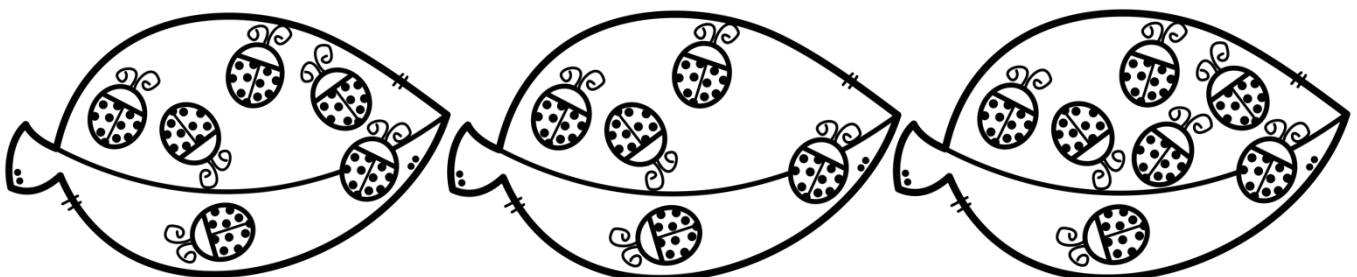

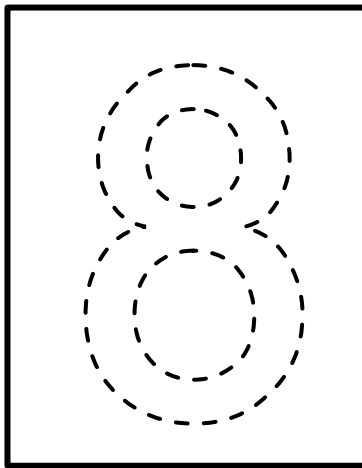

οχτώ

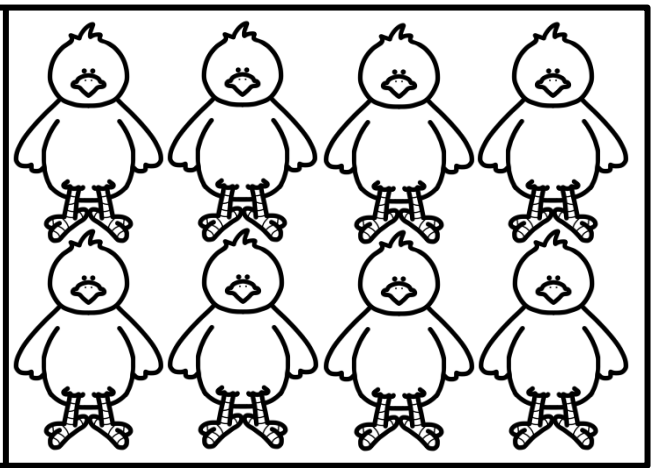

Γράφω το 8

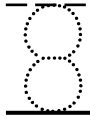

Κυκλώνω το 8

9	8	0	2
8	5	8	8
8	3	8	1
8	6	8	8

Ζωγραφίζω  
οχτώ τρίγωνα

Χρωματίζω το δοχείο που έχει 8 βόλους

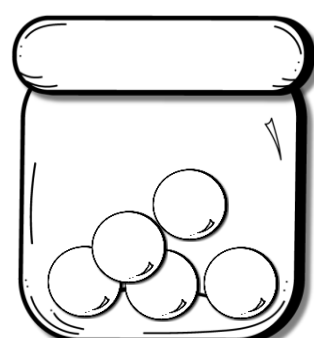
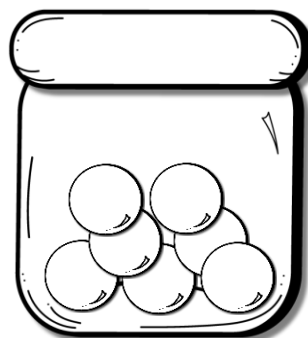
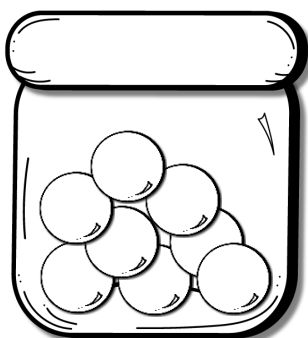

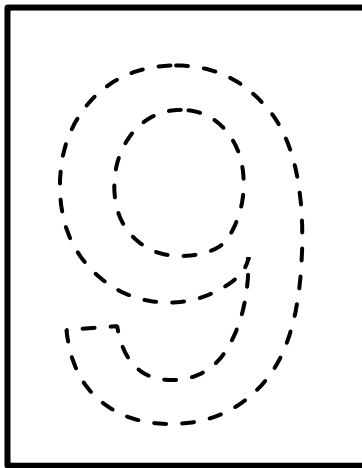

**εννιά**

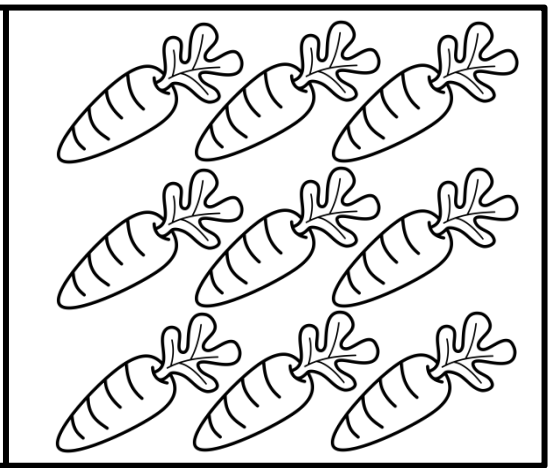

Γράφω το 9



Κυκλώνω το 9

9	9	5	1
9	4	9	9
3	9	2	9
6	0		

Ζωγραφίζω  
εννιά φύλλα

Χρωματίζω το σχοινί που έχει 9 χάντρες

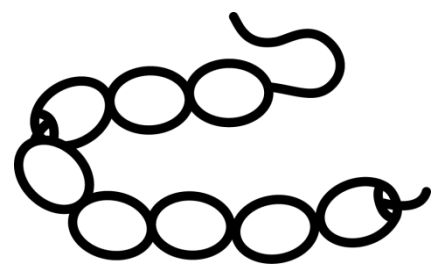
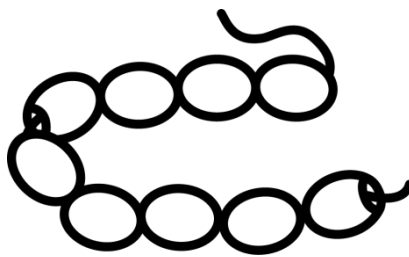
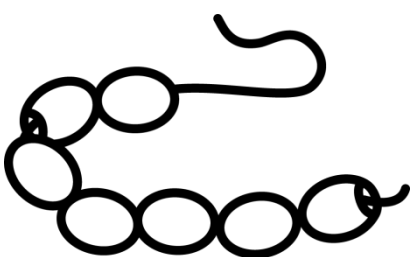

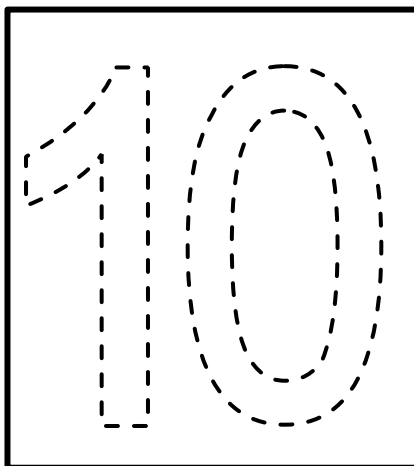

**δέκα**

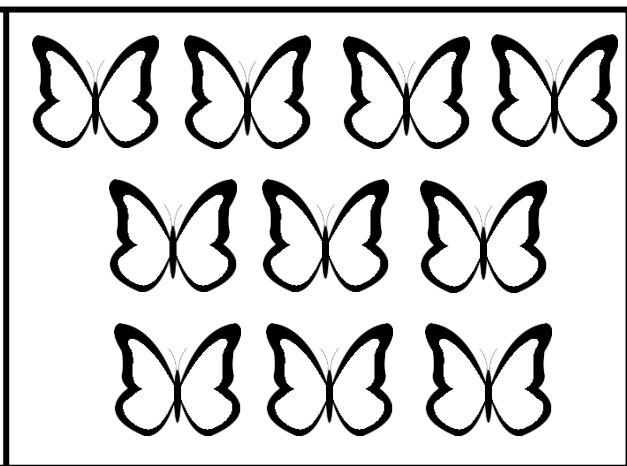

Γράφω το 10

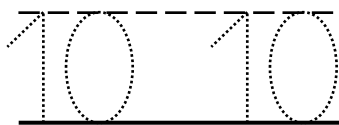

Κυκλώνω το 10

10	1	10	6
2	10	5	10
8	10	9	10
	3	0	

Ζωγραφίζω  
δέκα κύκλους

Χρωματίζω το μπισκότο που έχει 10 σοκολατάκια

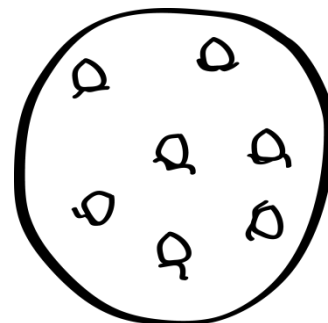
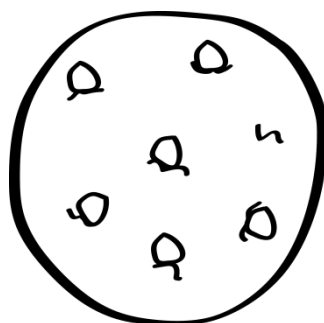
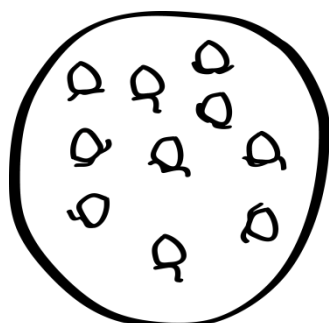
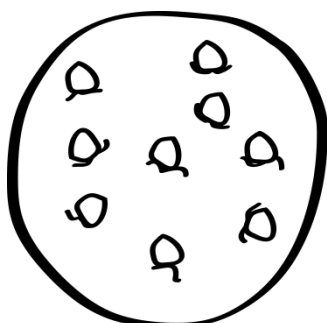

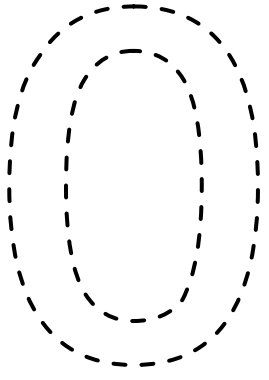

# μηδέν

Γράφω το 0

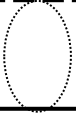
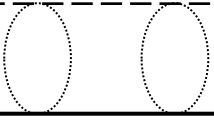

Κυκλώνω το 0

0 8 1 9  
5 3 0 0  
0 0 4 6  
7 0

Ζωγραφίζω  
το 0

Χρωματίζω τη γυάλα που έχει 0 ψάρια

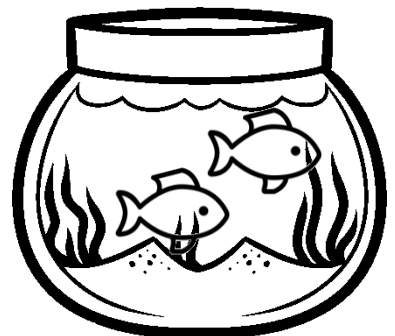
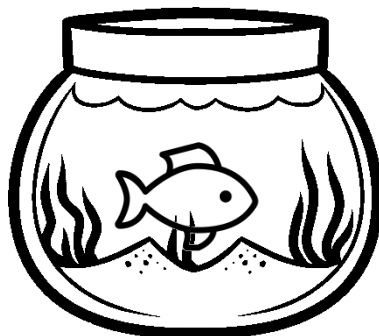



# Γράφω τους αριθμούς

0 1 2 3 4 5 6 7 8 9 10

0 1 2 3 4 5 6 7 8 9 10

0 1 2 3 4 5 6 7 8 9 10

-----

-----

-----

-----

## Αντιστοιχίζω

5                    3  
1                    8  
2                    7  
9  
6                    4  
10

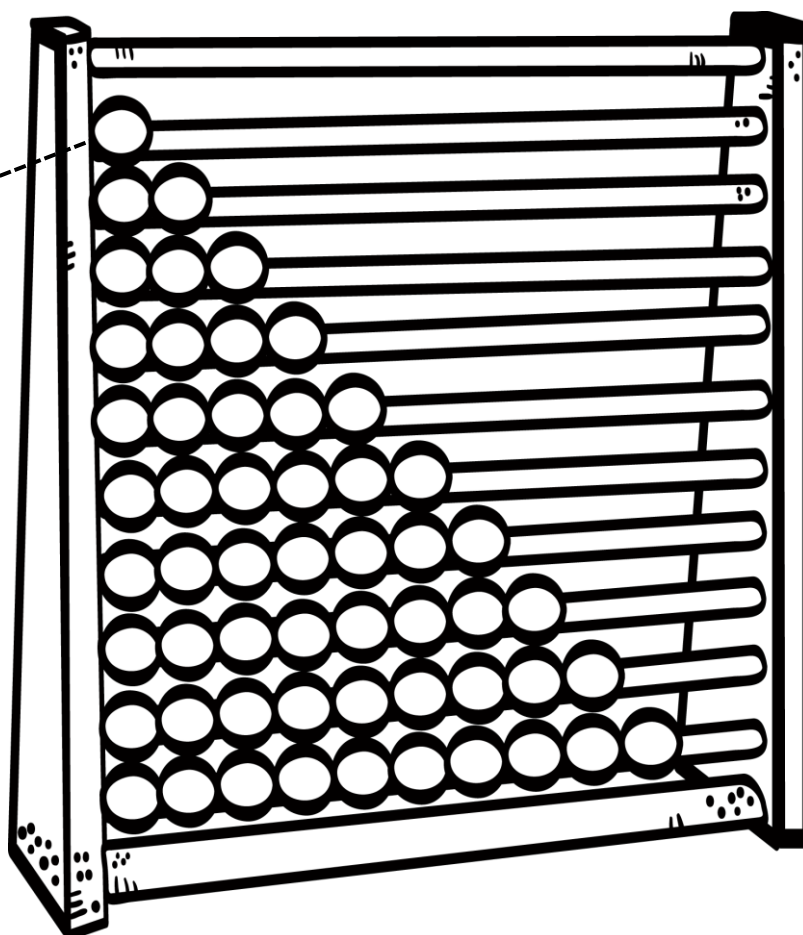

# Ενώνω τις τελείες και χρωματίζω

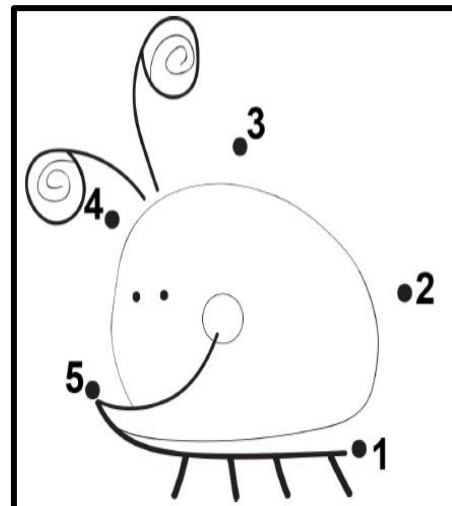
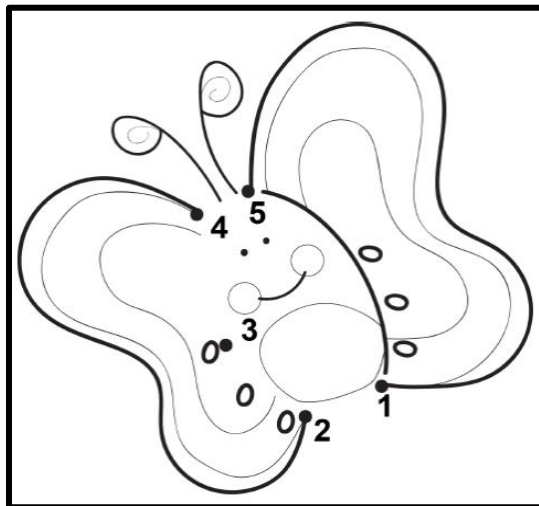
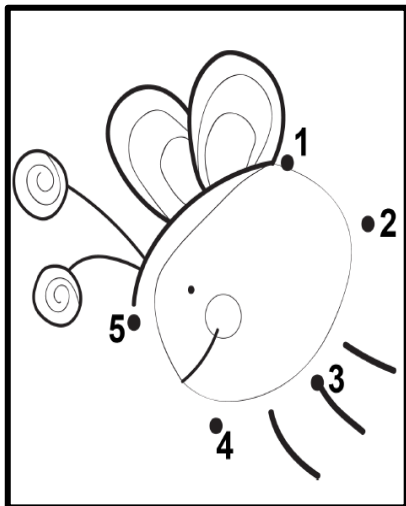

## Συμπληρώνω τους αριθμούς που λείπουν

0 1 2 <input type="checkbox"/>	2 3 4 <input type="checkbox"/>	0 <input type="checkbox"/> 2 <input type="checkbox"/>
0 1 <input type="checkbox"/> 3	1 2 3 <input type="checkbox"/>	2 <input type="checkbox"/> <input type="checkbox"/> 5
0 <input type="checkbox"/> 2 3	2 <input type="checkbox"/> 4 5	<input type="checkbox"/> 1 <input type="checkbox"/> 3
<input type="checkbox"/> 1 2 3	1 2 <input type="checkbox"/> 4	0 <input type="checkbox"/> <input type="checkbox"/> 3
<input type="checkbox"/> 3 <input type="checkbox"/> 5	<input type="checkbox"/> 2 <input type="checkbox"/> 4	<input type="checkbox"/> 1 <input type="checkbox"/> 3
1 <input type="checkbox"/> <input type="checkbox"/> 4	2 <input type="checkbox"/> <input type="checkbox"/> 5	2 <input type="checkbox"/> 4 <input type="checkbox"/>

# Μετρώ και γράφω τον αριθμό, στο κουτάκι

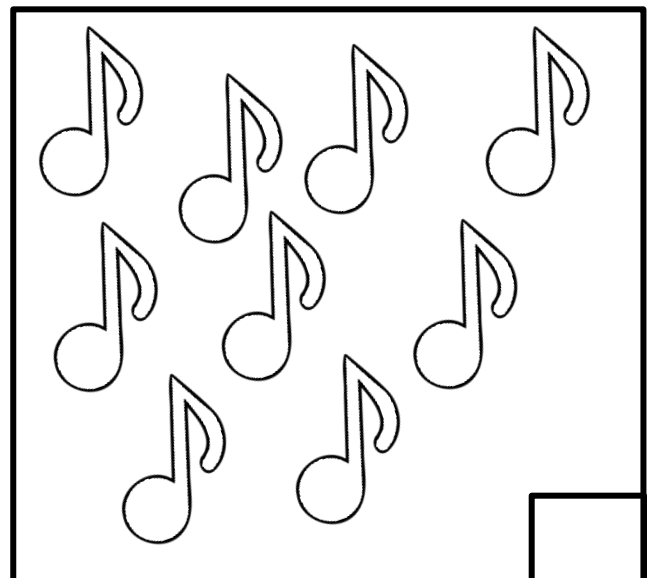
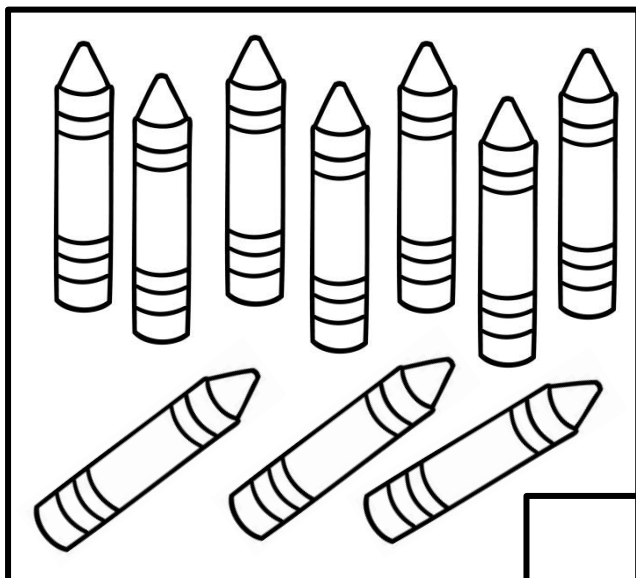
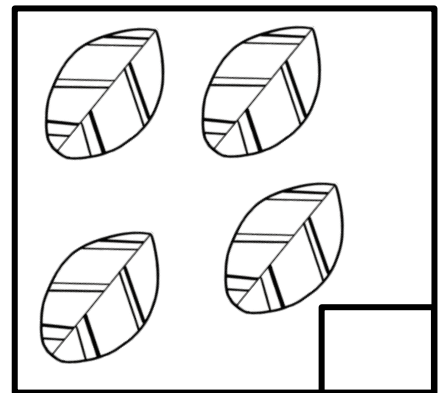
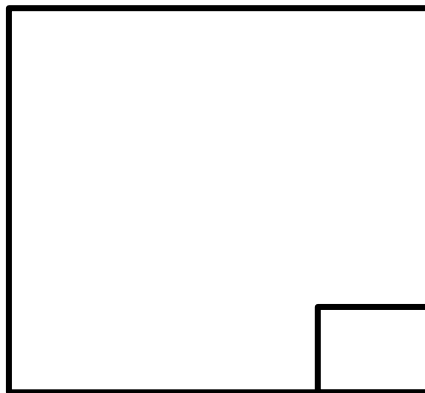
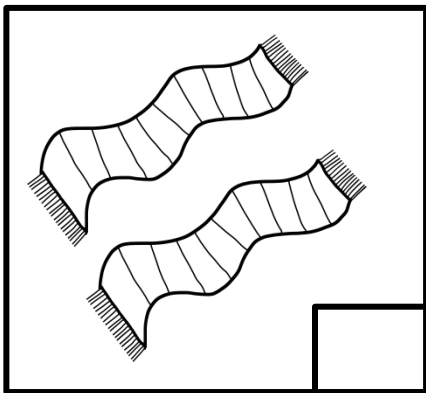
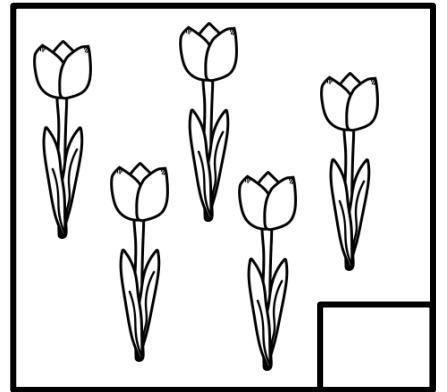
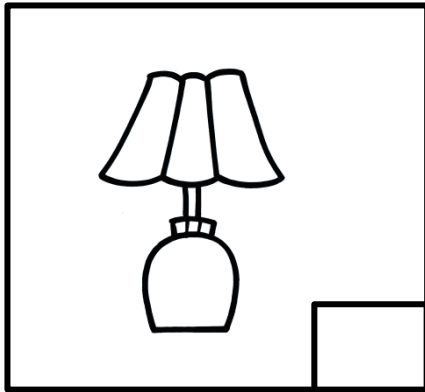
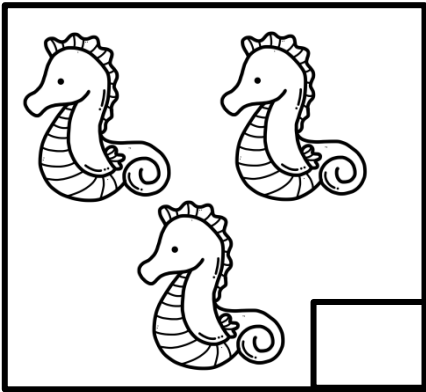
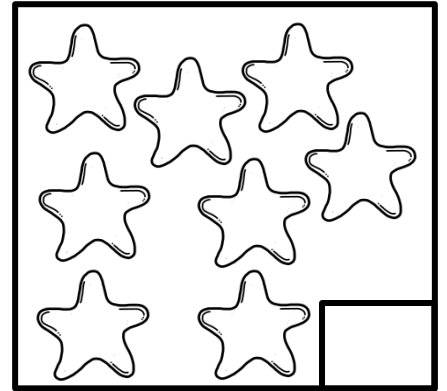
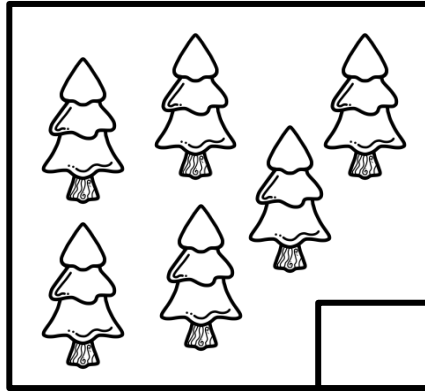
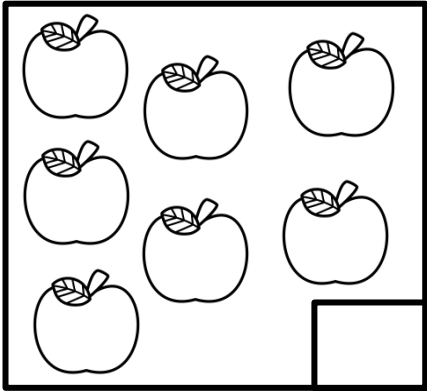

# Ζωγραφίζω

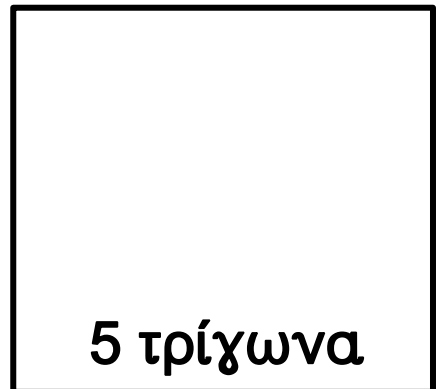
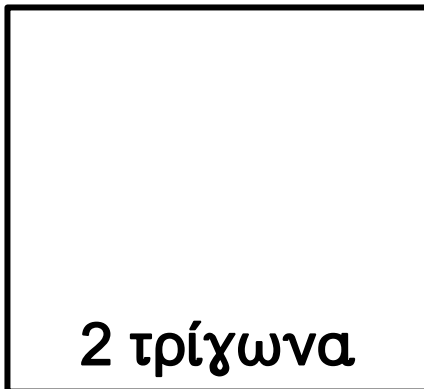
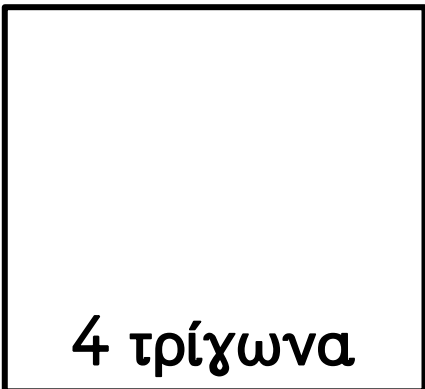

# Αντιστοιχίζω

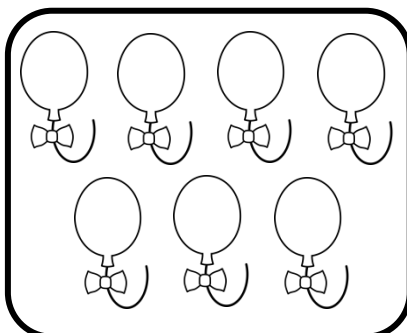
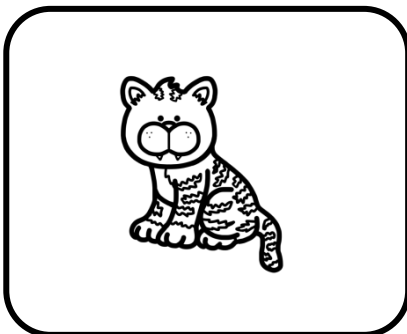
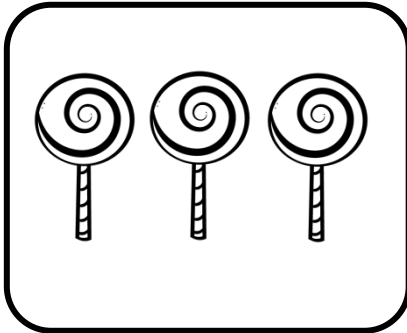
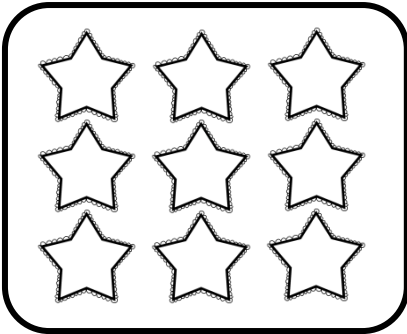
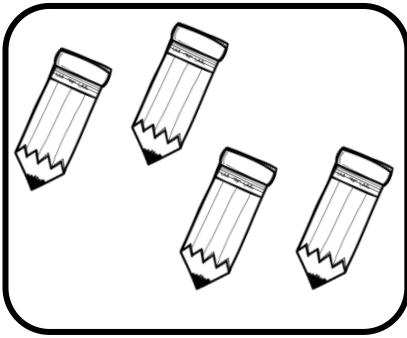

1

2

3

4

5

6

7

8

9

10

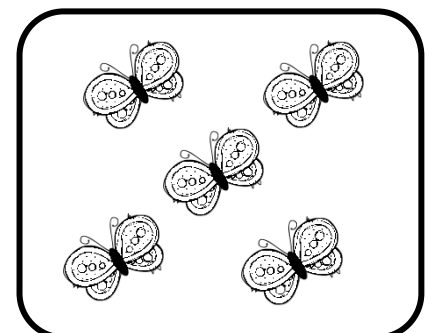
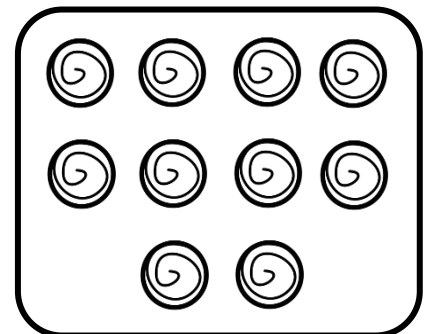
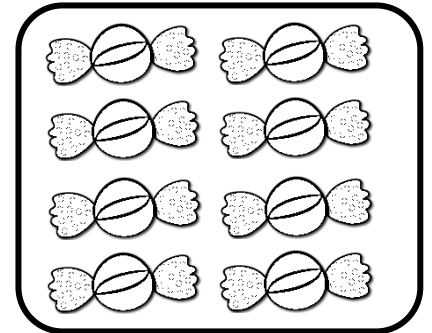
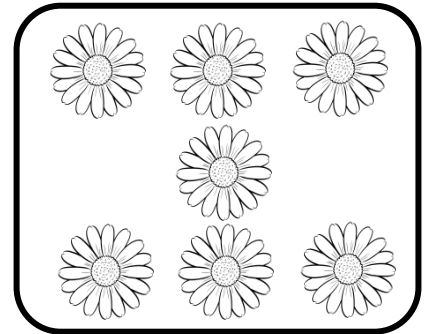
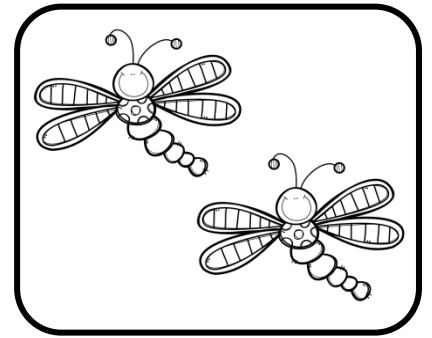

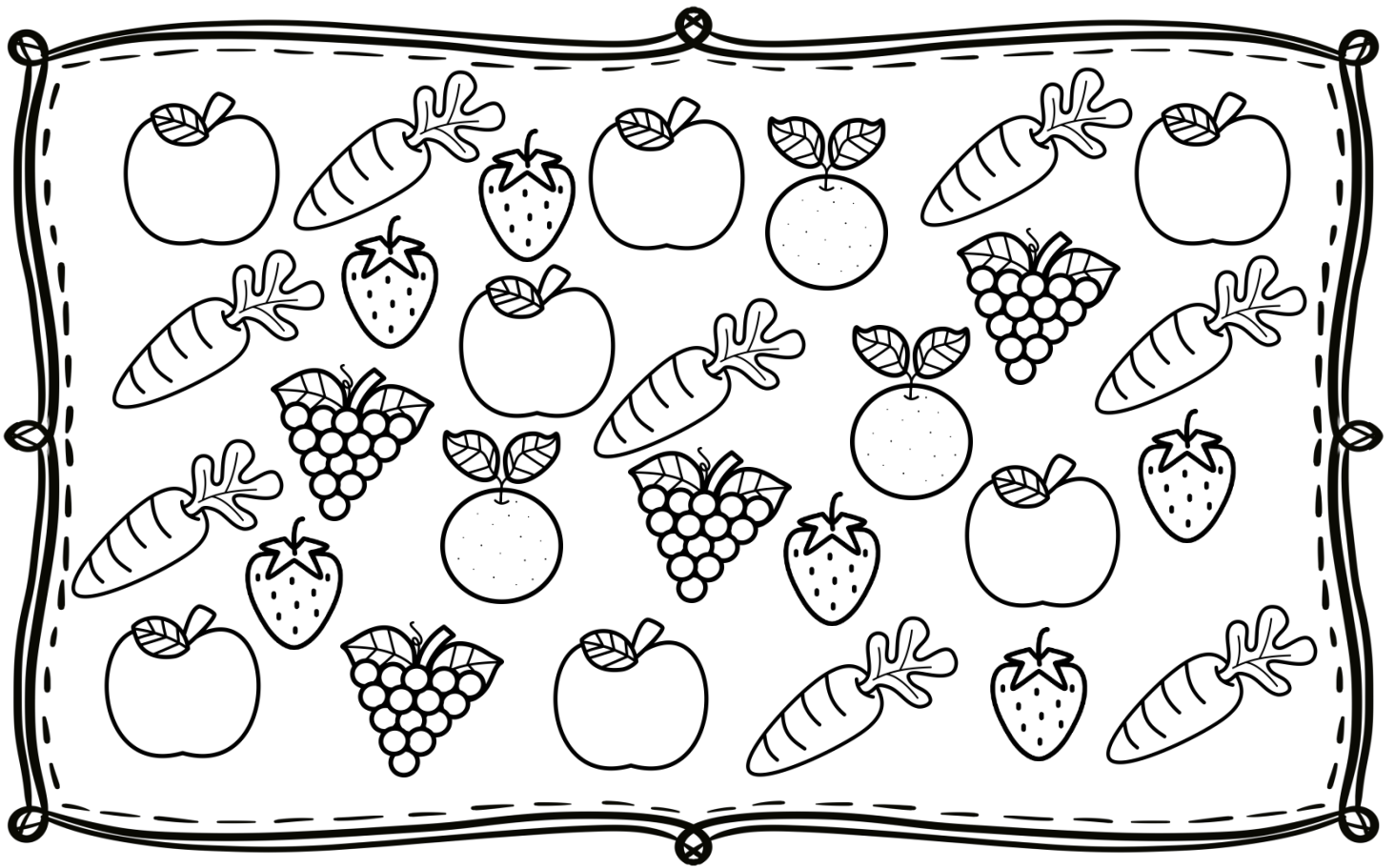

Μετρώ και χρωματίζω. Μετά, γράφω τον αριθμό στο κάτω κουτάκι.

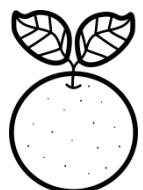
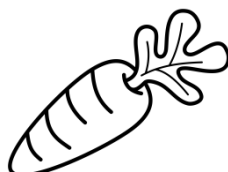
# Ενώνω τις τελείες και χρωματίζω

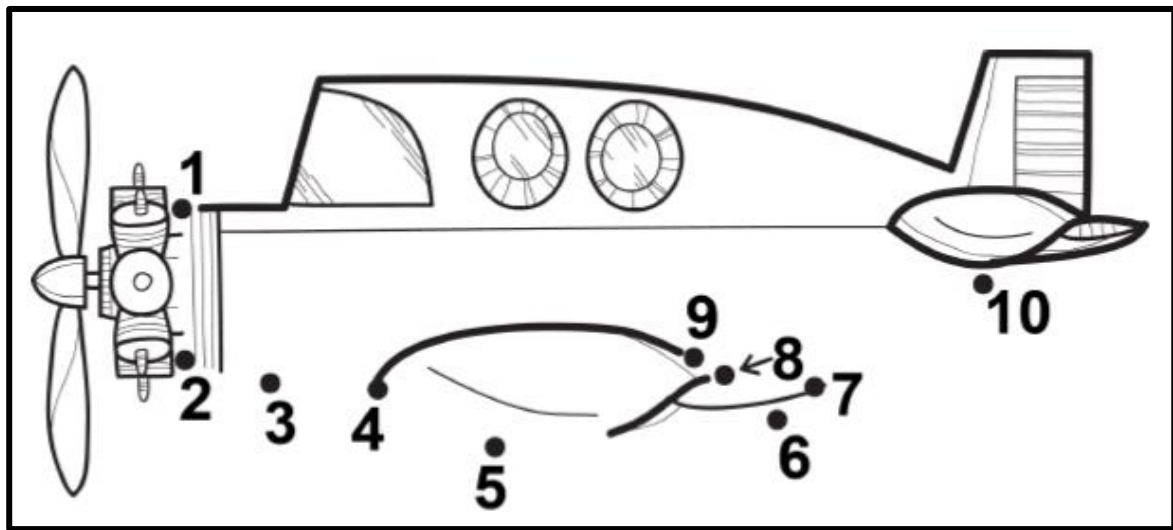
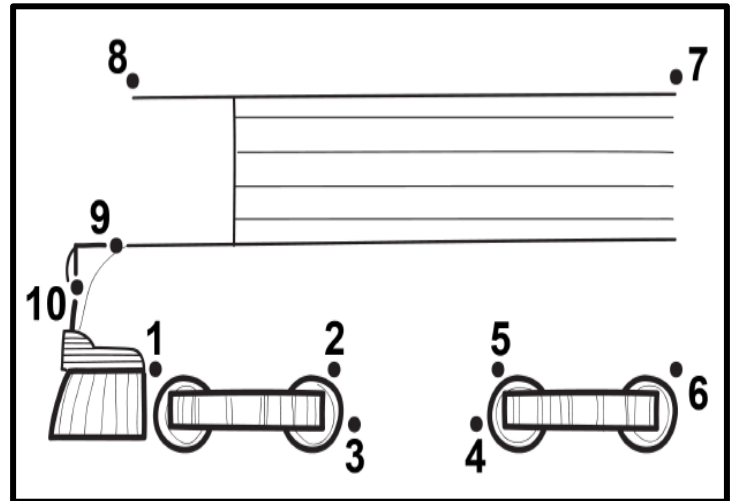
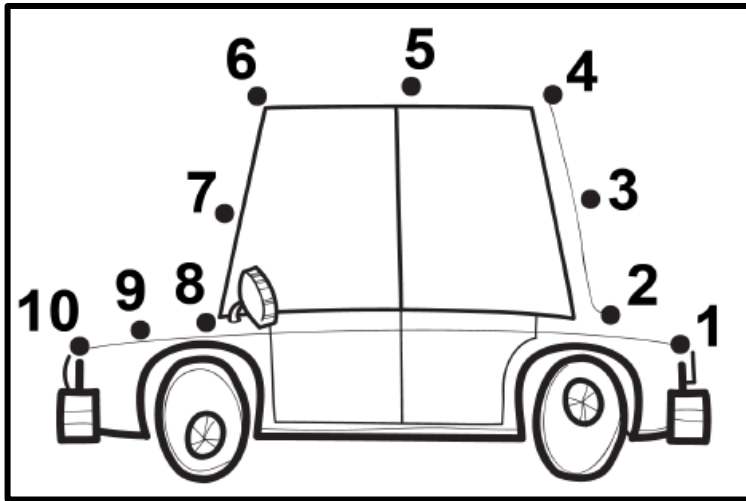

Συμπληρώνω τους αριθμούς που λείπουν

0 1 2  4 5 6 7  9 10

1   4 5 6   9

0     5     10



# Αντιστοιχίζω



τρία  
δέκα  
δύο

έξι

εφτά  
ένα

δέκα

οχτώ  
πέντε  
εννιά

τέσσερα

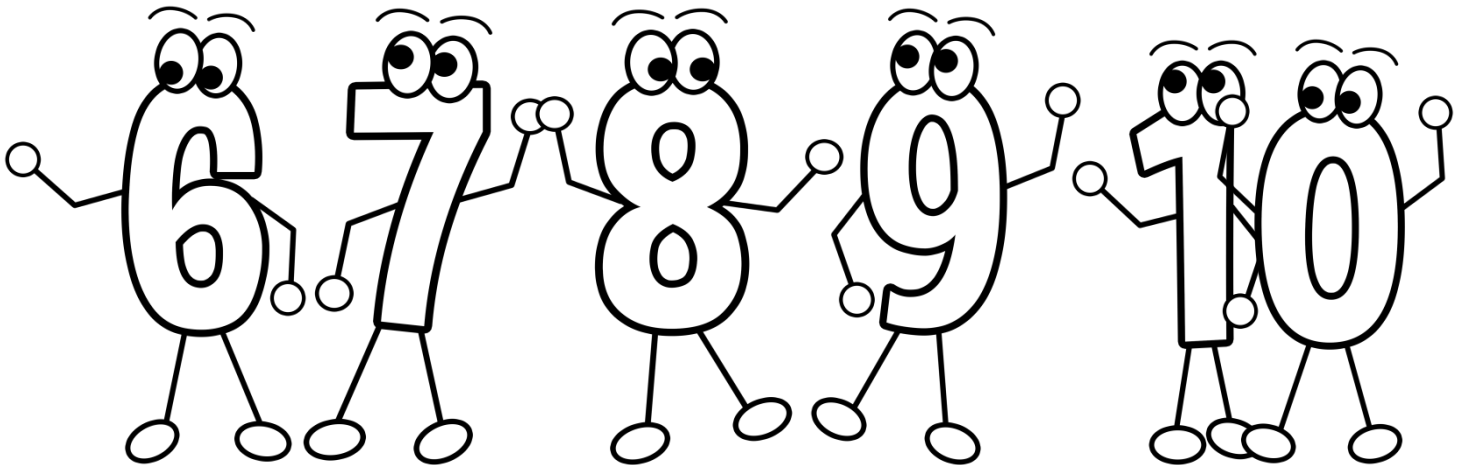

# Χρωματίζω τα κουμπιά της υπολογιστικής

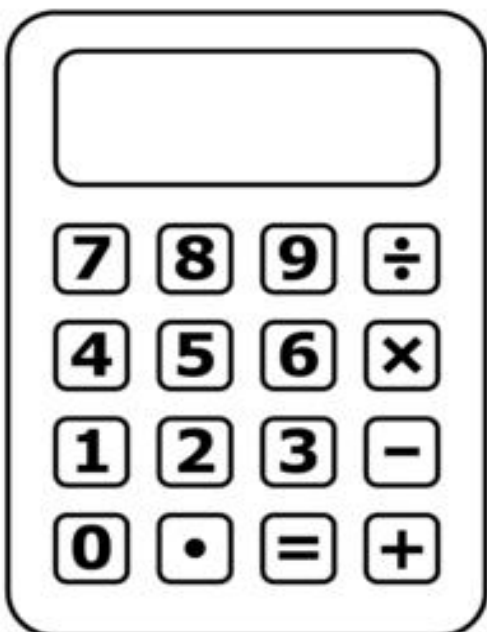

1 → κόκκινο

2 → κίτρινο

3 → πράσινο

4 → μπλε

5 → γαλάζιο

6 → πορτοκαλί

7 → μοβ

8 → ροζ

9 → μπλε

0 → καφέ

# Χρωματίζω

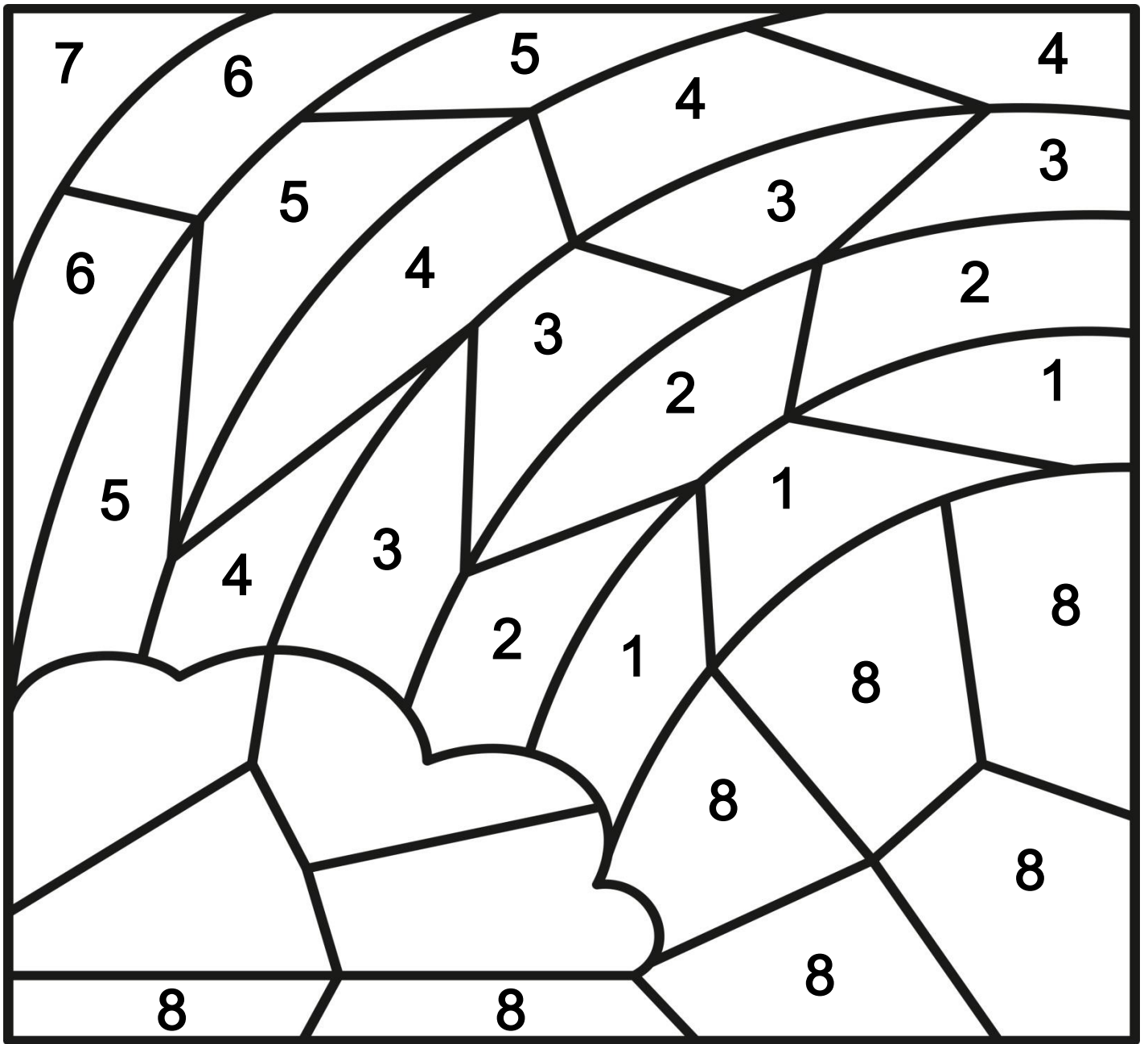

κόκκινο ( 1 ) 

πορτοκαλί ( 2 ) 

κίτρινο ( 3 ) 

πράσινο ( 4 ) 



μπλε ( 5 ) 

μοβ ( 6 ) 

ροζ ( 7 ) 

γαλάζιο ( 8 ) 

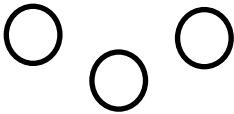
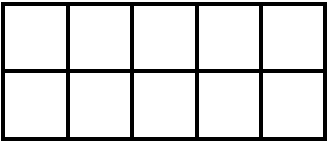
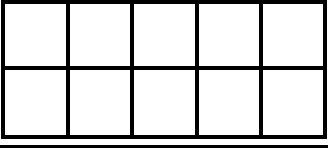
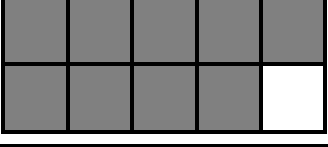
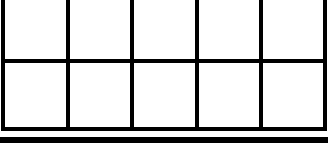
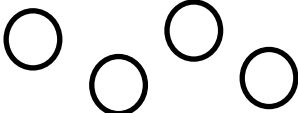
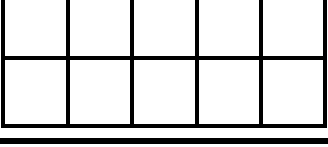
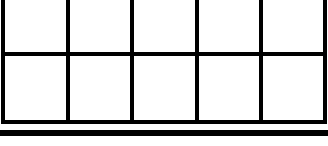
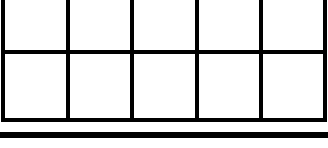
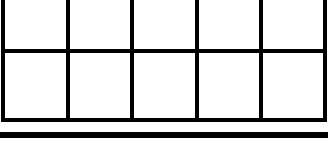
# Συμπληρώνω τον πίνακα

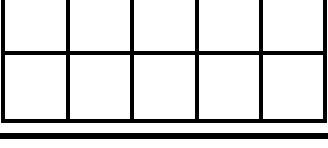
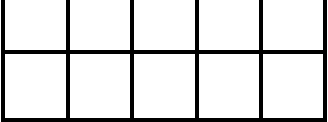
Γράφω τον αριθμό	Γράφω τη λέξη	Χρωματίζω κουτάκια	Ζωγραφίζω κύκλους
3	τρία		
5	_____		
	οχτώ		
	_____		
	_____		
2	_____		
	δέκα		
0	_____		
	_____		
	έξι		
	εφτά		

# Χρωματίζω

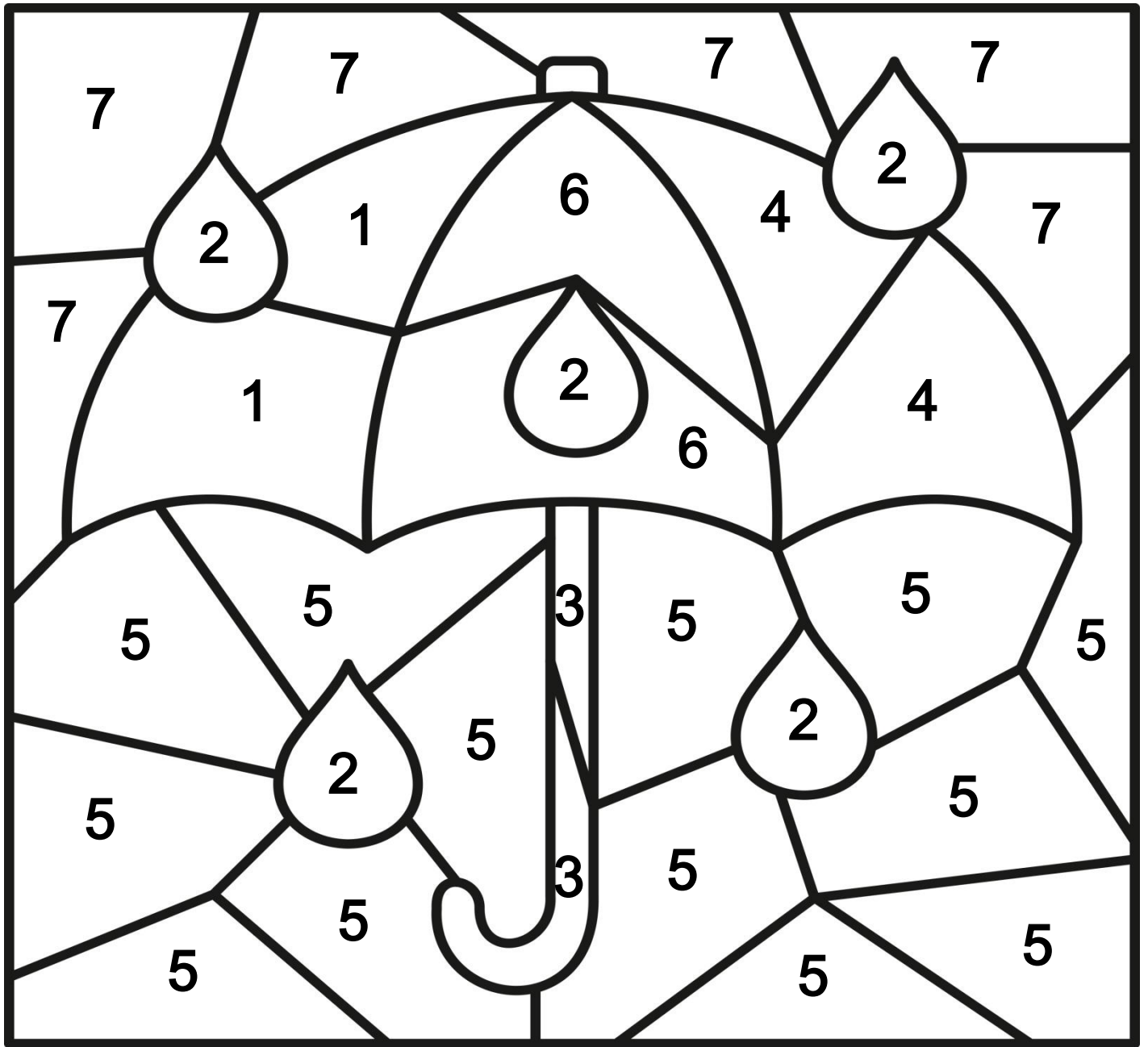

πράσινο ( 1 ) 

γαλάζιο ( 2 ) 

μαύρο ( 3 ) 

κόκκινο ( 4 ) 

μοβ ( 5 ) 

μπλε ( 6 ) 

κίτρινο ( 7 ) 

# Ζωγραφίζω

Να, 3 ψάρια στη γυάλα!

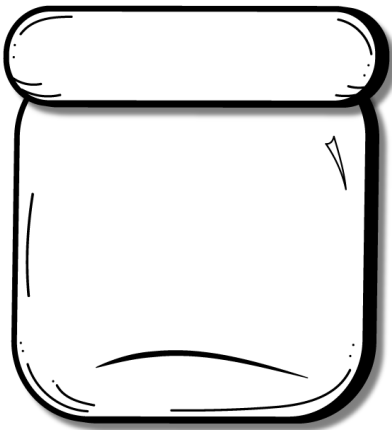

Να, 5 βόλοι στο δοχείο!



Η σακούλα έχει 6 καραμέλες.

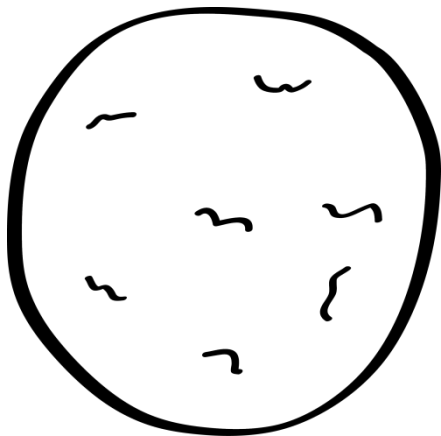

Το μπισκότο έχει 10 σοκολατάκια.

Να! Μία πασχαλίτσα στο φύλλο!

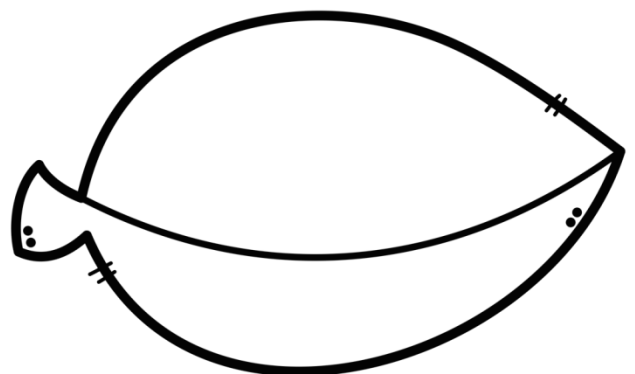

# Συμπληρώνω ή διαγράφω όσα χρειάζονται

4

5

6

3

7

8

1

5

0

10

2

Γράφω τον αριθμό, που είναι μετά από το...

1	
---	--

3	
---	--

5	
---	--

8	
---	--

2	
---	--

6	
---	--

0	
---	--

7	
---	--

9	
---	--

Γράφω τον αριθμό, που είναι πριν από το...

	2
--	---

	4
--	---

	3
--	---

	5
--	---

	9
--	---

	1
--	---

	10
--	----

	6
--	---

	8
--	---

Γράφω τους αριθμούς, που λείπουν

		6			9	
--	--	---	--	--	---	--



## Διαβάζω και χρωματίζω

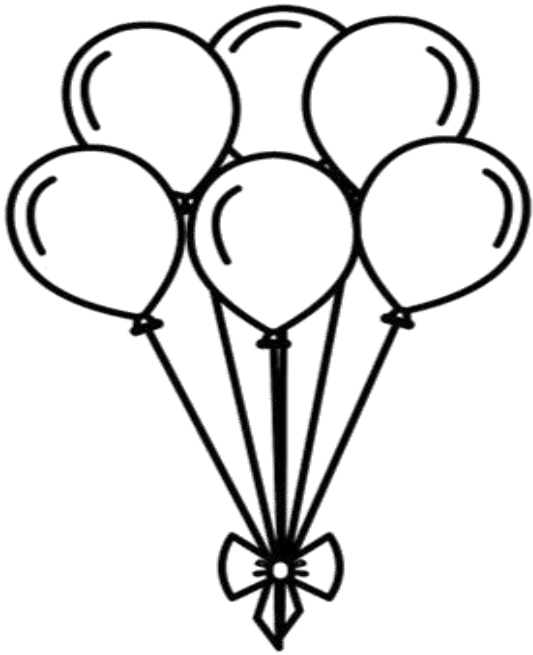

Ένα μπαλόνι είναι μπλε.  
Δύο μπαλόνια είναι κόκκινα.  
Ένα μπαλόνι είναι πράσινο.  
Δύο μπαλόνια είναι κίτρινα.  
Όλα τα μπαλόνια είναι .

Ένα κεριά είναι κόκκινο.  
Τρία κεριά είναι μοβ.  
Τέσσερα κεριά είναι χαλάζια.  
Τα υπόλοιπα κεριά είναι ροζ.  
Όλα τα κεριά είναι .



Το βάζο έχει  λουλούδια.  
Οι τουλίπες είναι κίτρινες.  
Η μία μαργαρίτα είναι κόκκινη.  
Η άλλη μαργαρίτα είναι ροζ.  
Όλα τα πράσινα φύλλα είναι .

0

1

2

3

4

5

6

7

8

9

10

*Κόβω τις  
καρτέλες*

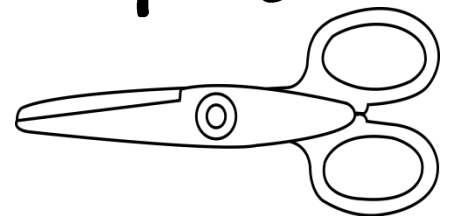

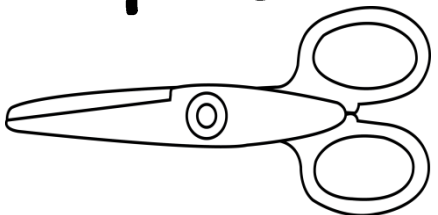
	○	○ ○
○ ○ ○	○ ○ ○ ○	○ ○ ○ ○ ○ ○
○ ○ ○ ○ ○ ○	○ ○ ○ ○ ○ ○ ○	○ ○ ○ ○ ○ ○ ○ ○
○ ○ ○ ○ ○ ○ ○ ○ ○	○ ○ ○ ○ ○ ○ ○ ○ ○ ○	<p><i>Κόβω τις καρτέλες</i></p> 

μηδέν ένα δύο

τρία τέσσερα πέντε

έξι επτά οχτώ

εννιά δέκα

*Κόβω τις  
καρτέλες*

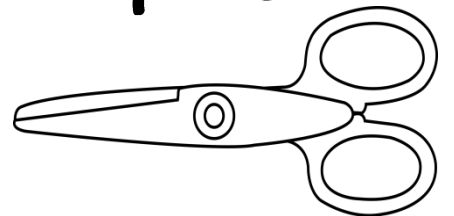

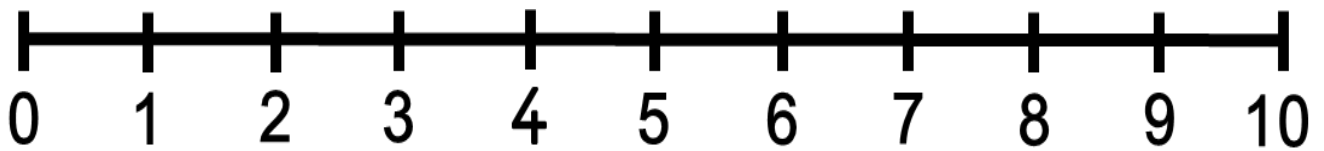
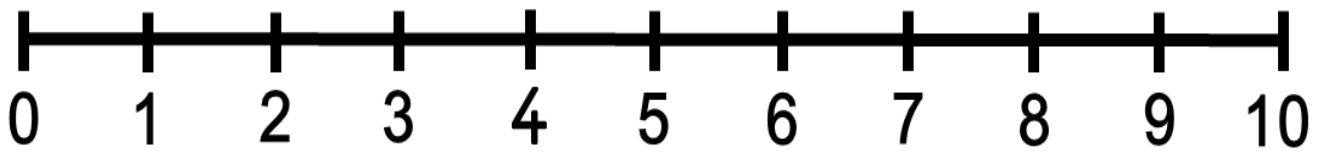
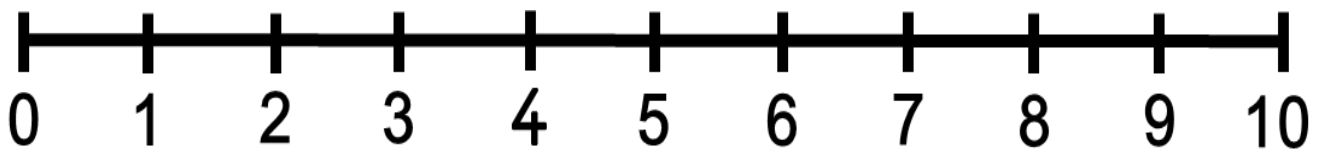
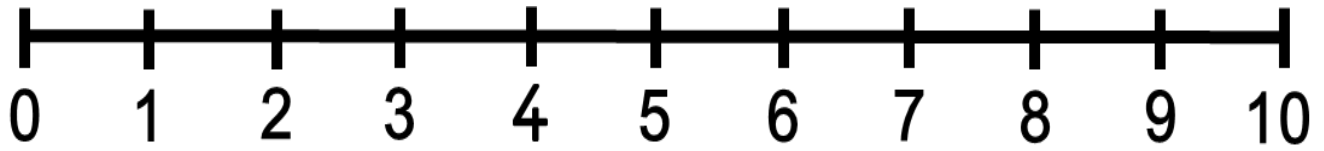
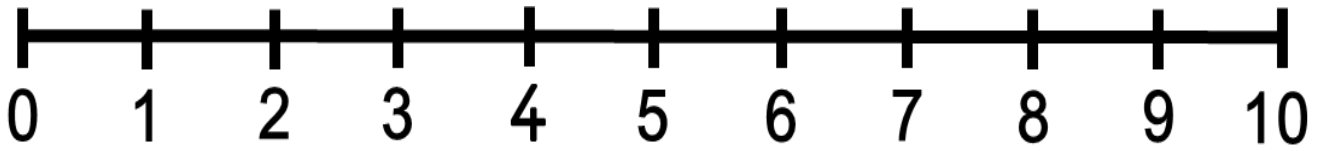
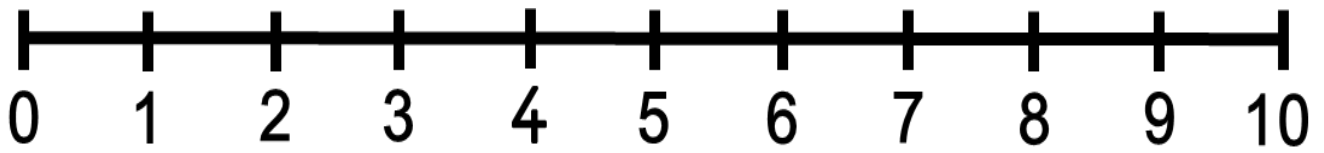

*Κόβω τις  
καρτέλες*

